

CONDITIONS AND REQUIREMENTS

- The subfloor must be clean, dry and free from cracks. Dust and contaminants that could prevent adhesion, such as patches of paint, oil, etc., must be removed. Note that asphalt, oil spillage, impregnation agents, pen marks, etc., can cause discoloration. Damp proofing to be carried out according to local building standards. Where required an effective damp proof membrane must be incorporated in the subfloor. Check for dampness in ground supported floors, floors above boiler rooms, floors with underfloor heating or containing hightemperature pipework etc.
- **When installing this product on concrete subfloors that do not include damp-proofing, the moisture content measured in terms of relative humidity must not be higher than 85% (in UK and Ireland 75% according to BS 8203). Or less than 2% with CM (Carbide Method)**
- Where pipes are laid in the floor they should be arranged so that the flooring material is not continuously subjected to a temperature above 27°C, otherwise there may be discoloration and/or other alterations of the material.
- Extra special care must be taken regarding installations on surfaces where significant temperature changes can be expected, for example, floors exposed to strong sunlight, as adhesion strength and subfloor treatment may be heavily stressed.
- Floor boards and similar substrates should have a moisture content of max 8% (equivalent to 40% RH at +20°C), so that any subsequent movements cannot cause damage.

PREPARATION

- Dust and loose particles must be thoroughly removed. Highly absorbent or variably absorbent substrates should be sealed with suitable primer. The primed surface must be completely dry before laying commences.
- When applying smoothing compounds, use compounds that meet the minimum requirements in the building standards.
NOTE: Discolouration can occur when using two-parts polyester compounds if they are mixed incorrectly and/or insufficiently. Do not mix directly on the substrate.

- Use only a lead pencil for marking. Note that any marks made with felt-tipped pens, permanent and non permanent ink markers, ball point pens etc. can cause discoloration due to migration.
- If material from several rolls is used, they should have the same manufacturing serial numbers and be used in consecutive order.
- Prior to laying, allow the material, adhesive and subfloor to reach room temperature, i.e. a temperature of at least 18°C. The relative air humidity should be 30-60%. **Rolls must be stored indoors.**
- **The rolls should be stored upright.** Any faults in the material must be reported immediately to your nearest sales office. Always quote the colour and roll numbers, which are stated on the label.

INSTALLATION

- Installation should be carried out at room temperature between 18°C to 26°C. Subfloor temperature must be at least 15°C. The relative air humidity in the premises should be 30-60%. Maintain same temperature and humidity for at least 72 hours after installation.
- Cut the sheets to length and, if possible, lay them out to acclimatise prior to laying. This is particularly important for longer lengths.
- The sheets are fully adhered with an adhesive approved for Tarkett's homogeneous vinyl sheet. **See the adhesive manufacturer's instruction regarding coverage, open time etc.** The assembly time depends on the type of substrate, its absorbency, the temperature and air humidity in the premises.
- **Sheets must be installed so that colour differences are avoided. Reverse sheets whenever possible.**
- Rub the face surface down thoroughly to ensure that the floor covering makes good contact with the adhesive and that all air is expelled. Make sure that the tool used for rubbing down the floor covering does not scratch the surface. A broom is not suitable for this purpose. Use a floor roller (approx. 65 kg) and roll crosswise over the floor.

If any doubts or clarifications should be needed, please contact your local Tarkett representative for further information.

FITTING, COVING AND CORNERS

- The flooring is covered approximately 100 mm (4 in) up the wall. If wall covering is to be installed, then it should overlap the wall base by at least 30 mm (approx. 1 in). For the best result, the thickness of the wall base is levelled out before installation of the wall covering so that a smooth juncture is obtained, use a water-resistant levelling compound.
- Within 0,5 m radius from floor drains etc. seams are not recommended.

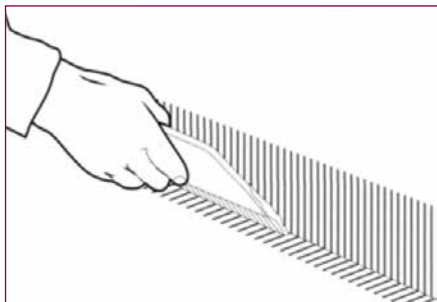

Using a straight edge and pencil, mark at a height of about 10 cm (approx. 4 in.) all walls where the flooring will be covered. Apply the adhesive on the walls up to the marked line, using a finenotched trowel. Spread some of the adhesive out onto the floor, as shown in the picture.

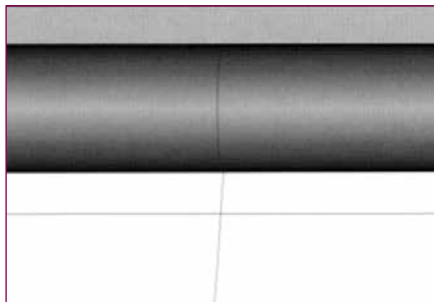

While the adhesive becomes tacky, the sheets are cut. The sheets should be cut longer than the room length to allow sufficient material for coving. When a sheet fits the width of the room, mark a cross mark on the bottom of the material and the subfloor to indicate the center. This will help you to place the sheet in its exact position. The cross marks are to coincide at installation.



When the width of the room exceeds the sheet width (more than one piece has to be installed to cover the area), mark a line on the floor parallel to the longitudinal wall at a distance equivalent to 12 cm (about 4 1/2 in.) less than the sheet width. Mark the room's center on this line. On the bottom of each sheet, mark their center. The cross marks on the subfloor and sheets shall coincide at installation.



Fold back and loosen the sheets covering half of the floor area. Apply the adhesive on the subfloor with a fine-notched trowel. Use a soft brush around drains and hard-to-reach areas. Around and inside drains, please see drain manufacturers recommendation.



Use a Tarkett Hockey Stick or Tarkett Corner Roller to press the material firmly into the juncture between the floor and wall. In areas where one sheet is sufficient to cover the subfloor, the adhesive can be applied over the entire surface area before installing the sheet. Although this requires experience, it is the fastest installation method.

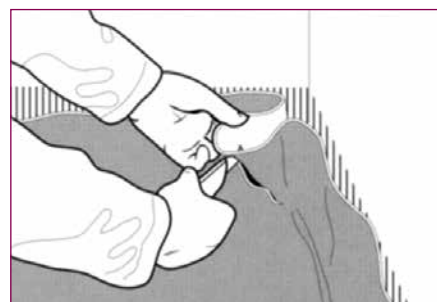

When fitting in-corners, make a cut in the excess material starting about 5 mm (about 1/4 in.) above the floor in the corner. If the material has to be heated before folding, heat the area between the sheet and the wall. This provides better contact between the sheet and adhesive.

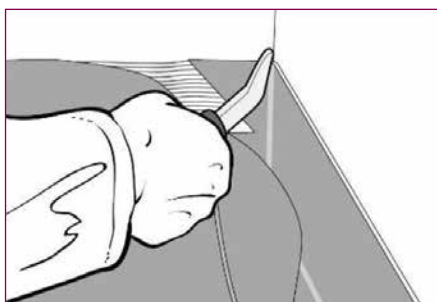

Press the material firmly into the corner with a Tarkett Corner Roller or Tarkett Hockey Stick.

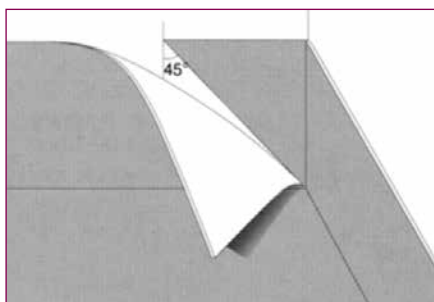

The corner seam shall be placed on one of the walls at a 45-degree angle.

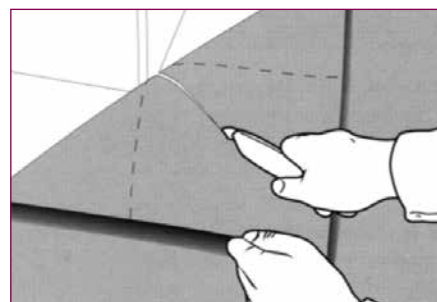

When fitting an out-corner, the sheet is folded against the corner and cut about 5 mm (1/4 in.) from the floor. The guidelines in the picture show the corner on the sheet and the position of the cut at about a 45-degree angle. Then a diagonal cut is made as shown.

If any doubts or clarifications should be needed, please contact your local Tarkett representative for further information.

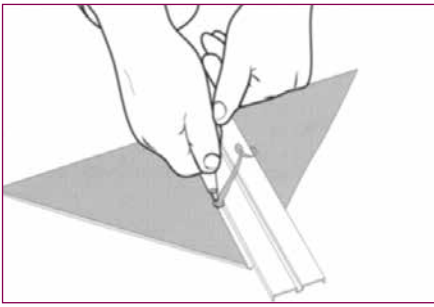

To glue the triangle-shaped piece more simply and securely, cut a groove on the back of the triangle with Tarkett Corner Knife. The depth of the groove shall be no deeper than half of the sheet thickness.

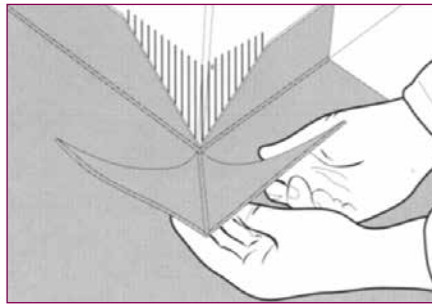

The triangle can now be folded and placed on the corner. It will overlap the covered floor. Cut through the overlapping material to make a tight fit.

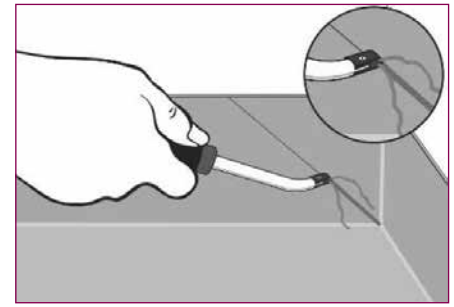

All seams on floor and coving must be grooved before welding.

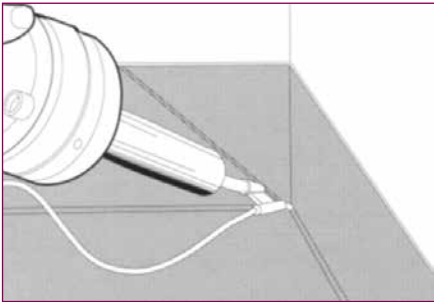

Use a hot-air gun for welding with thread at in-corners and out-corners. Tarkett Speed Welding Nozzle is specially designed for welding vinyl floors. For a perfect job, the Tarkett Swan Neck is required to effectively seal all seams nearest to the floor.

N.B. Prior to sealing in the corner, make sure that the PUR reinforcement is completely removed from the surface.

FITTING AROUND PIPES AND FLOOR DRAINS

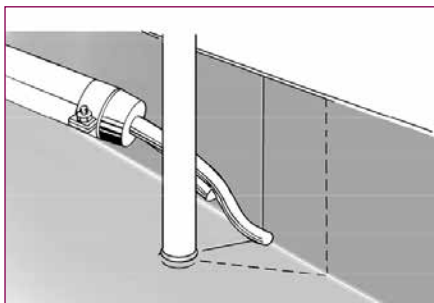

Around pipes by walls, cut the sheet and press it against the pipe to form a collar. In tight or cramped areas between pipes and walls, cut as shown by the dotted line. If a cover is required, do the following:
1) If you make a cover out of floor material, fit it against the pipe with adhesive. Weld the seams together using the Tarkett Swan Neck.

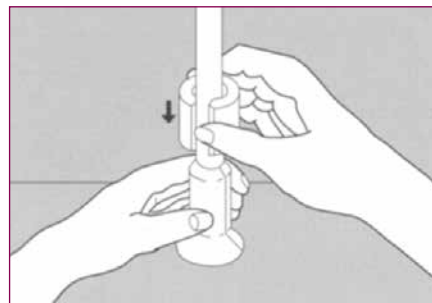

2) Prefabricated covers are applied according to the manufacturer's instructions. Seam sealer or sealing compound approved for this purpose, can be used for an extra tight fit around pipes.

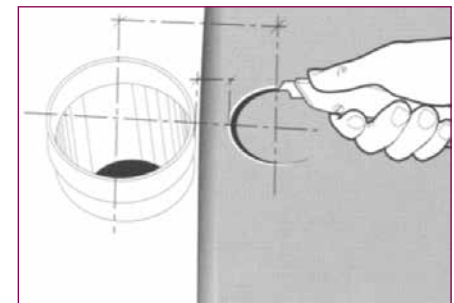

Around drain pipes, fold the sheet against the pipe and mark a line on the material where the center of the pipe is. Cut a hole about 25 mm (about 1 in.) smaller than the diameter of the pipe. As shown, cut the hole at the start of the fold. Heat the sheet vinyl and press it over the pipe. Trim off excess material with a hook knife so that the break in the pipe wall is cleared.

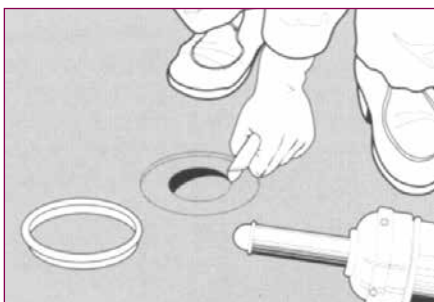

Around flush drain openings, heat the sheet and mark the location of the drain using a clamp ring. Then cut a small hole in the centre of the drain within the mark. Heat the flooring and press the clamp ring down into the edge of the drain. When using an adjustable clamp ring, make sure it fits tightly. Trim the material around the perimeter of the ring.

Alternatively; use cutting tool as per recommendation from the drain manufacturer.

Always ask for complete instructions from the drain manufacturer!

If any doubts or clarifications should be needed, please contact your local Tarkett representative for further information.

WELDING

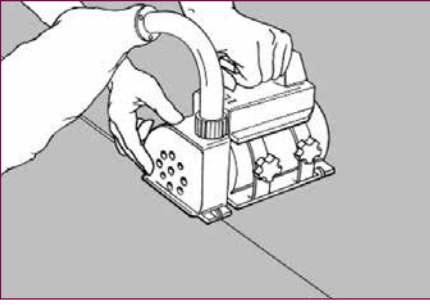

The sheets are heat welded. Do not weld until the adhesive has bonded completely. The joints are chamfered or grooved to about $\frac{3}{4}$ of the thickness using a hand grooving tool or machine prior to welding.

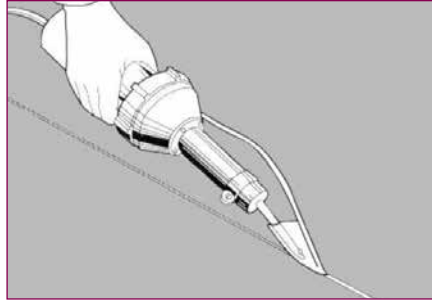

Weld with hot-air and Tarkett Speed Welding Nozzle. Carry out a test welding on a leftover piece before commencing work, to adjust speed and temperature

IMPORTANT: When welding iQ Megalit, a Tarkett Speed Welding Nozzle or equivalent should be used.

TRIMMING

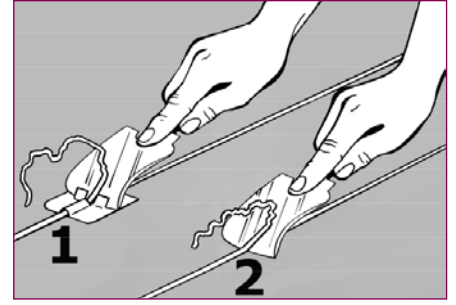

CAUTION: Welded seams must cool to room temperature before trimming. Start trimming where you began welding. All trimming of welding thread is recommended in two steps: rough and fine trimming.

INSPECTION

■ The work must be completed with an inspection. Ensure that the newly laid flooring is free from adhesive residues and that the bond is consistent with no bubbles.

GENERAL

■ This information is subject to change due to continuous improvement.

FOR THE BEST RESULTS

- Make sure all specifications and instructions are followed carefully.
- Use only adhesives recommended by adhesive manufacturer.
- Contact your Tarkett representative if unsure about any part of the installation.

- Item No. 1258008 Corner Knife
- Item No. 1258003 "Hockey Stick"
- Item No. 1258027 Seam Grooving Tool
- Item No. 1258028 Spare Blade for Seam Grooving Tool
- Item No. 1258012 Speed Welding Nozzle
- Item No. 1258014 Clean Brush for Speed Welding Nozzle
- Item No. 1258021 Welding Nozzle Swan Neck

If any doubts or clarifications should be needed, please contact your local Tarkett representative for further information.