

# Installation Instruction

<b>Transport &amp; storage</b>	<b>1</b>	
<b>Handling</b>	<b>2</b>	
<b>Subfloor control</b>	<b>3</b>	
<b>Installation</b>	<b>4</b>	
<b>Inspection</b>	<b>5</b>	
<b>After installation</b>	<b>6</b>	
<b>Reminder</b>	<b>7</b>	

Collection iD Inspiration 55-70  
Soft Walnut Dark Brown / Rock Grege  
Wimereux / 2015

# 1. TRANSPORT & STORAGE

In general the rolls and boxes must be stored in a sheltered clean and dry indoor place and free from any pollution. Before installation, the rolls with 2m width should be stored upright and safely secured; other dimension above 2m should be stored horizontally. Tiles should be stored flat in their packages, in small neat piles (not more than 5 boxes high in the locality prior to installation).

They should also be protected from extreme temperature (heat and cold), moist, rust, rot, free from any contamination and not piled-up nor crushed under heavy weight. State of the art handling must be respected.

Rolls and tiles must be stored during 48 hours before starting the operation. For installation, room temperature should always be above 15°C or 18°C for linoleum. *Check the rules in your country; those temperatures could be different.*

Before installation, sheets and tiles should relax minimum 24h, out of packaging.

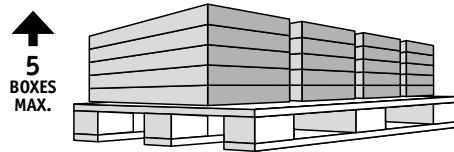

► For modular products

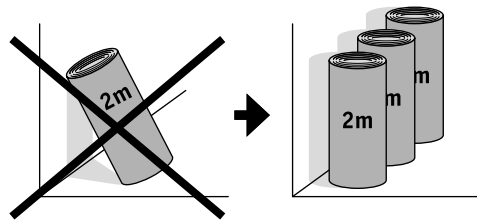

► For 2m rolls: upright storage

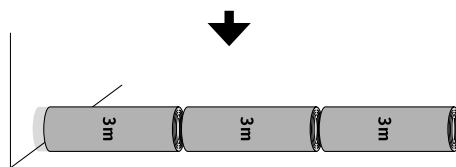
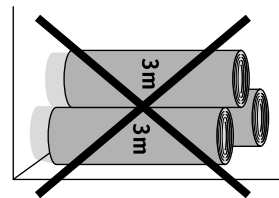

► For ≥2m rolls: horizontal storage

# 2. HANDLING



For the best results, follow the installation instructions below, and use the tools and the accessories recommended by the manufacturer.

Care should be taken when handling all types of floorcoverings to ensure that safety procedures are followed and damage does not occur to the material or people.

Check the material for visible defects and/or damage before and during installation and report to Tarkett representative.

For each continuous surface use the same batch number and install rolls/boxes in sequential order

► Trolley

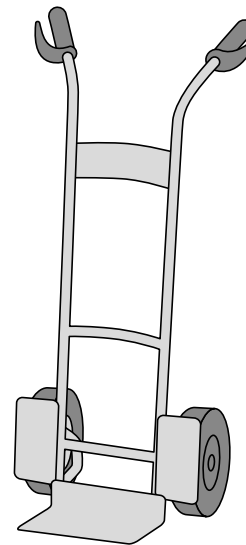

► Roll carrying handles

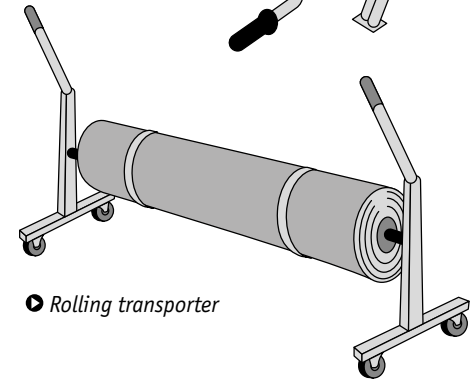
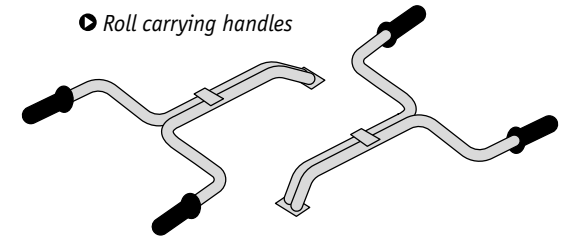

► Rolling transporter

Wrong transport, storage and/or handling could damage the flooring, causing aesthetical or technical issues. Tarkett does not warrant or guarantee flooring problems caused by inappropriate storage or handling.

# 3. SUBFLOOR CONTROL



The subfloor quality is the 1<sup>st</sup> condition for a successful installation, so make sure it is in good condition to do a flooring installation.

Always bear in mind that in most countries, the installer is responsible for the acceptance of the subfloor on which he will do the installation. He will then be held responsible for any potential claim/litigation.

The subfloor must be flat, clean, free from all debris & residues, without any marks (no felt pen, marker of any type, ballpoint pens, paint, etc. that could cause discolouration due to migration) sound, dry, solid, hard, smooth.

The absorbency must be checked and subfloor should not be exposed to humidity. The preparation/dryness of the subfloor and installation procedures should all be as per the current relevant Standard within the country of use. The dryness of a solid subfloor should be below the maximum moisture level permitted when tested in accordance with the said Standard. *Check the rules in your country to define the appropriate method and values.*

For marking, only use a non-oily graphite pencil.

## 3.1 SUBFLOOR CHARACTERISTICS

### ■ Humidity rate

Always refer to each country regulations. For info, the drying time of a concrete floor is approx 2 weeks per cm. For testing, refer to the regulations valid in your country (Relative Humidity test, Calcium carbide system...).

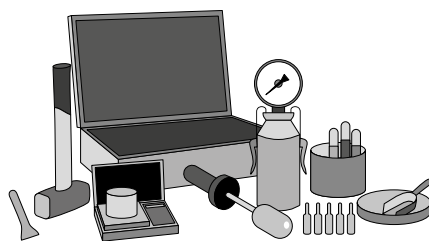

► Calcium Chloride Moisture Test Kit

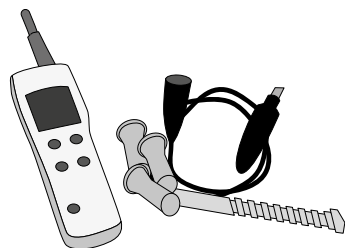

► Concrete Moisture Meter

Excessive humidity rate can cause disbonding, bubbles, colour migration that Tarkett does not warrant or guarantee.

### ■ Absorbency – Porosity

Check local regulations, but in general a subfloor is said too absorbent when the absorbency time of a drop of water on concrete is less than one minute. In this case, a primer must be used before leveling compound, with a 1/1 dilution.

A subfloor is said non-absorbent when the absorbency time of a drop of water on concrete is more than 10/ 15 minutes. In this case, the primer should be used non-diluted.

Prior to the use of a primer, always follow manufacturer's instructions.

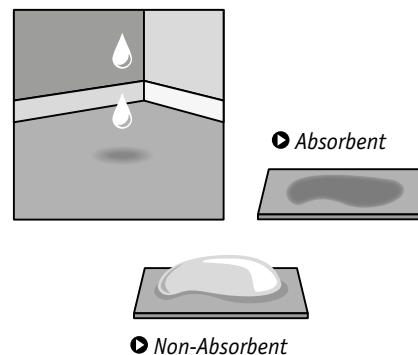

Non-absorbent subfloor could lead to a longer waiting time of the adhesive generating trouble in the bond plane. Too absorbent subfloor could lead to a shorter waiting time of the adhesive that could cause disbonding issue.

### ■ Planarity / Flatness

Different ways for measuring acc. countries.

France: tolerance must be less than 7mm over 2m for concrete subfloor and 5 mm for wood subfloor.

- UK/Nordic: 3mm over 2m (& depending on localities, SR1 or 2...).

- Germany: 4mm over 2m (Din 18202).

- NL/Australia: 2mm over 2m.

Tolerance must be less than 2mm over 20 cm of concrete/wood subfloor.

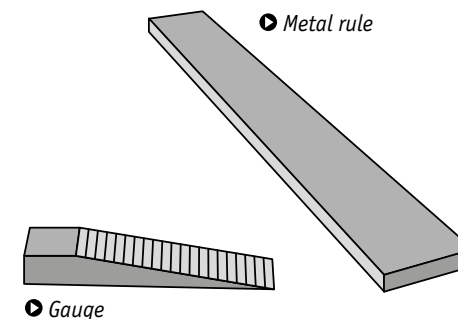

Non-flat surface could lead to visual issues or generate additional cost for the installer when using more levelling compound to recover the surface flatness.

# 3. SUBFLOOR CONTROL



## ■ Cracks & joints

First step will be to identify the type of crack or joint that will be discovered on the building site to adapt the treatment.

### Cracks

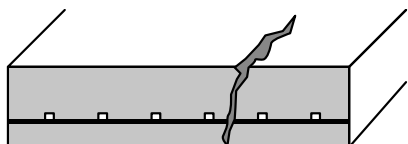

Cracks (0.3 to 1mm large) can appear during the drying of the concrete by contraction.

### Micro-cracks

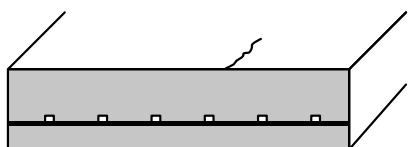

Cracks almost not visible ( $\leq 0,3$  mm large).

### Expansion joints

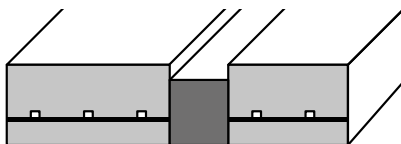

Expansion joints are used to compensate dimensional variations and building movements.

### Isolating joints

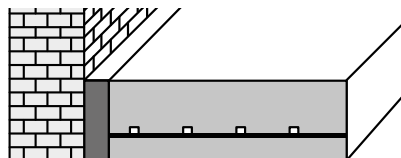

Isolating joints separate the screed from other independent building constructions (walls, pillar).

### Contraction (dividing) joints

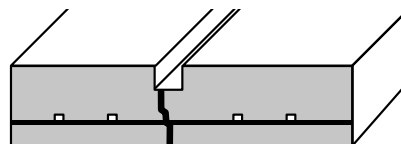

Contraction joints allow free contraction of concrete and avoid cracks during drying.

### Construction joints

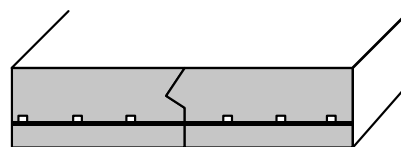

Construction joints are used to stop daily pouring of concrete slab.

## ■ Hardness

The subfloor has to be resistant enough to compression and indentation.

To measure the hardness of the concrete, installer can use a sclerometer.

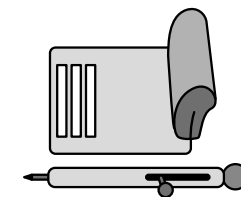

Isolating joints separate the screed from other independent building constructions (walls, pillar).

When the subfloor is not hard enough, significant traffic or heavy load could damage screed/levelling compound and could cause visual/technical defects.

## ■ Sound

The subfloor has to be free from contaminants such as hydrocarbon stains, paints, chemical residues or laitance on the surface.

Any contaminant left on the subfloor could cause colour migration and product damage.

## ■ Clean

The subfloor has to be free from any particles, dust, traces of felt pen or marker.

Particles, scratches and residues could cause visual defect (telegraphing effect).



Micro-cracks should be treated with a primer.

Cracks and construction joints should be sawed, cleaned and full filled with an epoxy resin on which sand will be spread.

Contraction joints should be full filled with an epoxy resin on which sand will be spread.

Expansion joint will be treated with a profile inserted or overlapped. Levelling compound and floorcovering will be stopped on both sides.

Isolating joints will be filled with soft material (e.g. polystyrene).

# 3. SUBFLOOR CONTROL



## 3.2 SUBFLOOR TYPES - PREPARATION

### ■ New subfloor

#### Concrete/cement base

**Preparation:** water base primer compound + self levelling compound adapted to the traffic level.

#### Wood or wood particles/plywood base

**Preparation:** wood adapted primer compound recommended, direct installation possible or add a special wood fiber levelling compound.

For wood base, you should check:

- flexibility (thickness - length)
- fixing – cupping (opening)
- glued grooves and tongues
- caulking of joints (wood paste)
- sanding (smoothing).

#### Bitumen base

**Preparation:** neoprene vinyl emulsified primer or bitumen adapted primary + bitumen adapted self levelling compound.

#### Anhydrite base (humidity rate < 0.5% CM)

**Preparation:** sanding of the surface then apply an adapted primer or emulsion, in principle, screeding is not necessary.

#### Metal

**Preparation:** apply an anti-rust primer + gluing, after thorough cleaning of any oily residue.

### ■ Old subfloor (renovation)

#### Terrazzo or ceramic tiles

**Preparation:** 1<sup>st</sup> make sure that all tiles are still well bonded to subfloor. Removal of surface coating or sealer - Apply an emulsified primer + adapted self levelling compound.

#### Wood parquet (glued, not floating)

**Preparation:** 1<sup>st</sup> check that all wood planks and pieces are well in place, solid and securely fixed, then apply a primer or adapted emulsion + fibre reinforced self levelling compound specific for wood.

**NOT recommended for HOMOGENEOUS Vinyl Products.**

### ■ Old floorcovering

#### Textile

**Preparation:** must be fully removed, scraped, and then apply a self levelling compound adapted to the area.

#### Vinyl

**Preparation:** we recommend removing all old floorings (for security, fire regulations, migration prevention etc...), scraping and applying an emulsified primer + self levelling compound adapted to the area.

It may exceptionally be possible to install over old HO compact Vinyl floorings or even VCT type which are in good conditions & well bonded to the subfloor, and mainly applicable for small areas. Two possibilities: thorough cleaning and de-greasing of the surface & either install directly after application of an acrylic base adhesive adapted for PVC on PVC installation. Or, application of cement base levelling compound, according to manufacturer's recommendations.

**If installing over old floorcovering, specific safety regulations have to be strictly followed. Please check with all local regulations. For heavy duty usage, old floorings must be removed.**

### ■ Underfloor heating

Stop heating at least 48h before screeding and/or floorcovering installation.

Re-start heating progressively 48h after installation (few degrees per day).

In case of underfloor heating, we recommend that the vinyl tiles are hot welded.

The temperature should never exceed the floorcovering industry agreed maximum of 27°C. Ensure that the room temperature will remain at minimum 18°C for installation.



# 3. SUBFLOOR CONTROL



## 3.3 MATERIALS FOR INSTALLATION

### ■ Primer

#### Different types:

solvent/water based, PU, Epoxy.

#### Main actions:

- grade the site & the over-absorbent and/or different subfloor surfaces.
- grade the permeability of subfloor where drying time could be too quick
- improve the bonding performance of the leveling compound on non-porous subfloor.

#### Application:

in general, the primer is applied with a brush/roller. Consumption depends on the planarity of the subfloor: 80 - 120 g/m<sup>2</sup>.

**Strictly follow manufacturer's instruction.**

Applying a leveling compound without using first a primer could cause delamination or cracks of the levelling compound.

### ■ Self-levelling compound

#### Definition:

Is a smoothing cement based compound finish for indoor use that will be covered by a floorcovering.

#### Main actions:

- rectify the subfloor porosity = possibility to glue without any particular preparation
- self levelling action resulting in homogeneous & smooth surface

- allow regularity of glue layer and drying time on the whole surface.

Consumption (average):

1.5 Kg / 1 mm / m

Heavy duty = 2-3 mm thickness (acc. country).

**Strictly follow manufacturer's instructions.**

### ■ Adhesive

Although Tarkett may recommend a selection of manufacturer adhesive, we do not however guarantee the products listed. The list of products and manufacturers are not guaranteed complete or current.

Tarkett would not accept any liability for any of these products failing to perform in conjunction with any of their products.

It is the responsibility of the adhesive manufacturer and flooring contractor to ensure the products being used are appropriate for use and applied in accordance with the manufacturer recommendations.

#### In general:

**Moderately absorbent subfloor: use finely notched trowel (approx. 250g/m<sup>2</sup> to 300g/m<sup>2</sup>).**

● For compact products (smooth backing): use **A1 spatula** (TKB model).

● For acoustic products (honey comb foam): use **A2 spatula** (TKB model).

**Non absorbent subfloor: use very finely notched trowel (approx. 150g/m<sup>2</sup> to 200g/m<sup>2</sup>).**

● May be the case for wall, Tarkolay, etc: use **A4 spatula** (TKB model).

#### For best selection, always check:

- Compatibility with the flooring product backing (PVC, PU, jute...)
- Aspect of the backing: rough, smooth, fibers, grid...
- Flooring porosity (textile, jute....)
- Subfloor porosity (absorbent or not)
- Quality/Performance (polyvalence, consumption...).

Consider flooring nature, subfloor type and conditions of use to determine the adhesive type and the spatula. According manufacturer's instructions and building site conditions, determine the drying and working time.

#### For linoleum:

**For Linoleum use a notched trowel, type will depend on the backing (approx. 300g/m<sup>2</sup> to 350g/m<sup>2</sup> for jute backing, 200g/m<sup>2</sup> to 300g/m<sup>2</sup> for foam backing).**

● For compact products (jute backing): use **B1 spatula** (TKB model).

● For acoustic products (foam backing): use **A2 spatula** (TKB model).

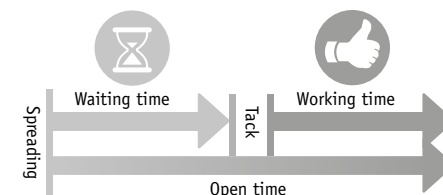

Waiting time = time needed till you are able to lay the floorcovering in the glue with correct bonding.

Working time = time for laying, heavy rolling and trimming of the floorcovering.

In general, the application of glue is made with a serrated spatula (TKB ref.: A1 for compact, A2 for acoustic, B1 for Linoleum...) or a roller (for special glue).

Before laying down the floorcovering, in case application require a drying time of the adhesive, always check that water or solvents are evaporated (finger test - no transfer). Other application may require wet bonding (see Manufacturer instruction) like for linoleum or LVT.

**Heavy roller must be used to ensure bonding.**

For more details on adhesives, please refer to the specific Tarkett Adhesive recommendation list.

[http://professionals.tarkett.com/sites/tarkettb2b\\_int/files/pdf/tarkett-floor-adhesive\\_recommendations.pdf](http://professionals.tarkett.com/sites/tarkettb2b_int/files/pdf/tarkett-floor-adhesive_recommendations.pdf)

# 4. INSTALLATION

Please refer to each individual installation notice per product range, adhesive chart with Tarkett selection as guide line.



## 4.1 GENERAL RULES

### ■ Laying - Sheets

#### 1 Room dimensions

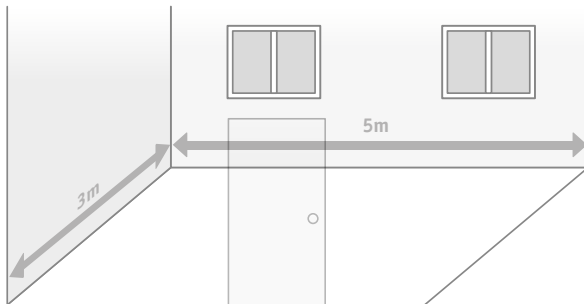

 If the room is reasonably square, the sheets should run parallel to the incoming light. In long, narrow rooms it is best to install the sheets along the length of the room.

#### 2 Layout nok

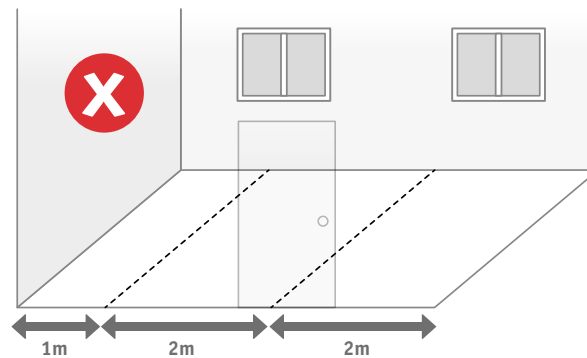

 Joint placed at a door step.

#### 3 Layout nok

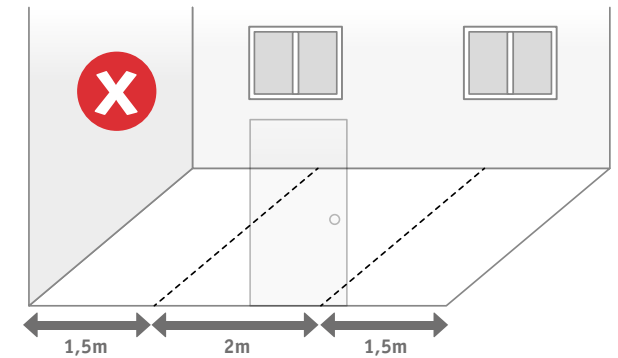

 Loosing material.

#### 4 Layout ok

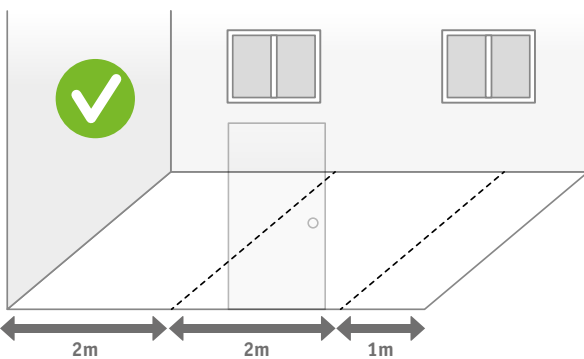

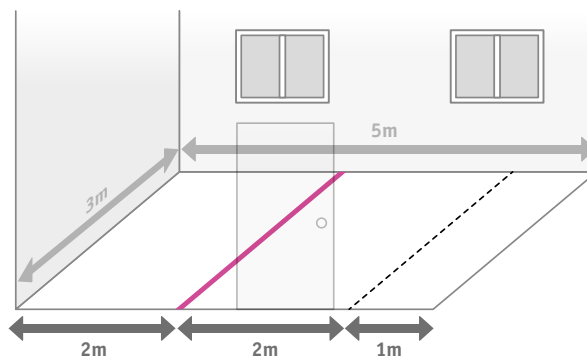

#### 5 Reference line

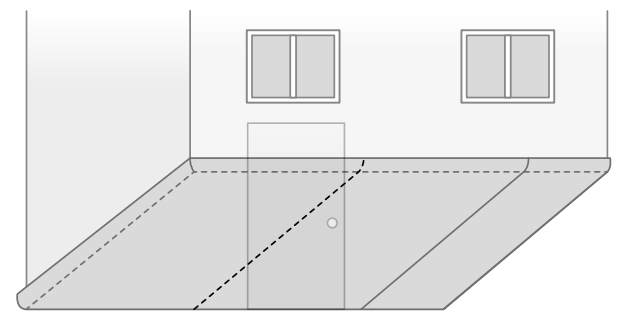

#### 6 Sheets preparation (cutting and relaxation)



 Align the sheet edge to the reference line.

 Sections of flooring must be cut to the required lengths, plus an allowance of a few centimeters.

# 4. INSTALLATION

Please refer to each individual installation notice per product range, adhesive chart with Tarkett selection as guide line.



## ■ Laying - Sheets

### 7 ► Half folding or rolling

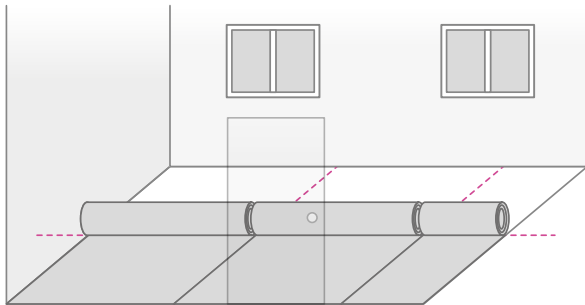

Can be rolled or fold.

### 8 ► Gluing

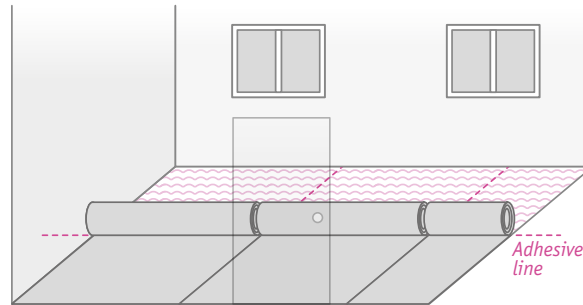

Spread the adhesive with the appropriate spatula.



Pay attention to spread adhesive till the line. For the second half, ensure not to let space without adhesive or to overglue.

### 7 ► First sheet folding back into the adhesive and pressing

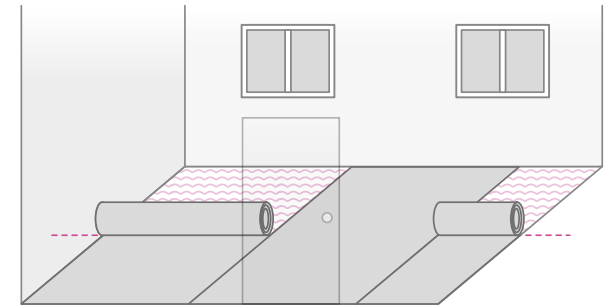

It's important to use the cork press when you gradually roll out the sheets onto the adhesive. In this way, you will avoid catching air under the sheets that may cause blisters later on.

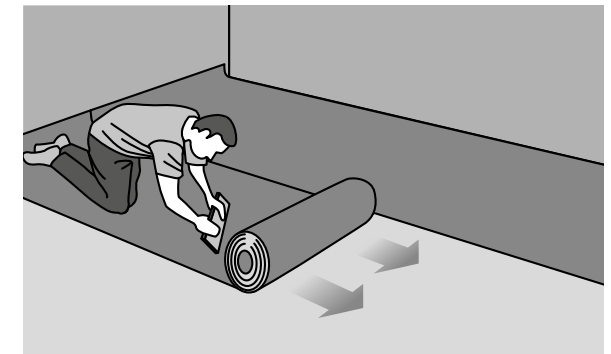



# 4. INSTALLATION

Please refer to each individual installation notice per product range, adhesive chart with Tarkett selection as guide line.



## ■ Laying - Sheets

10 ● Next sheets folding back and pressing

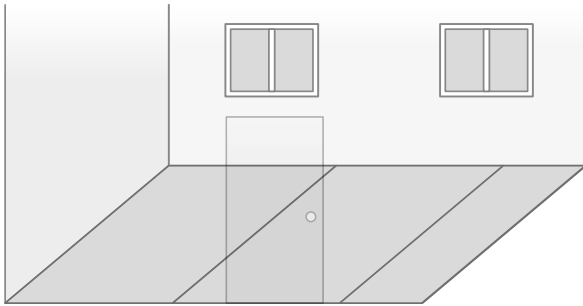

11 ● Repeat for the second half

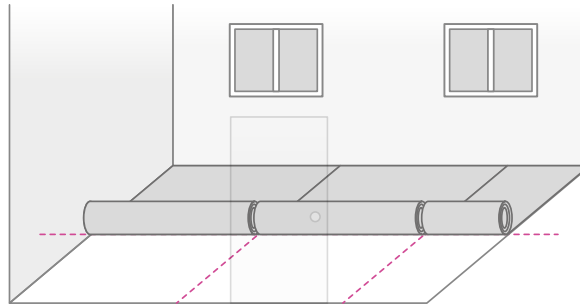

12 ● Gluing

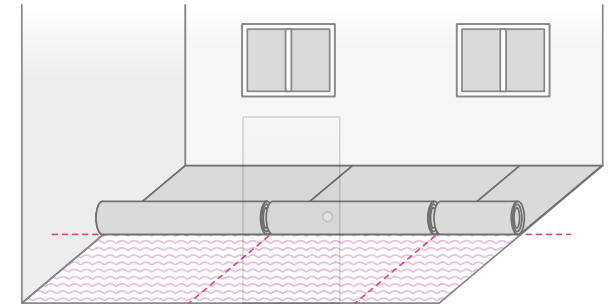

13 ● First sheet folding back into the adhesive and pressing

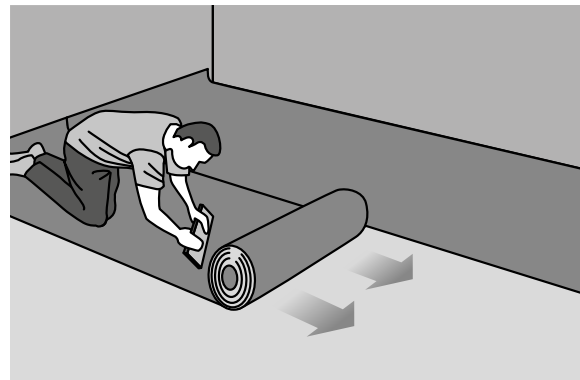
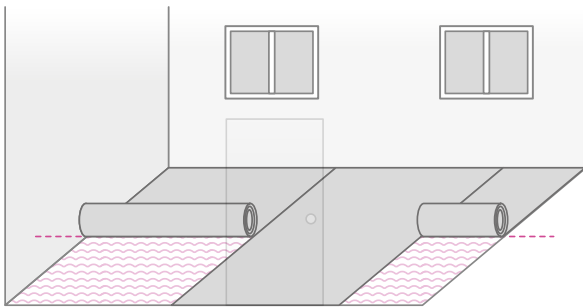

*It's important to use the cork press when you gradually roll out the sheets onto the adhesive. In this way, you will avoid catching air under the sheets that may cause blisters later on.*

# 4. INSTALLATION

Please refer to each individual installation notice per product range, adhesive chart with Tarkett selection as guide line.



## ■ Laying - Sheets

### 14 ◉ Next sheets folding back

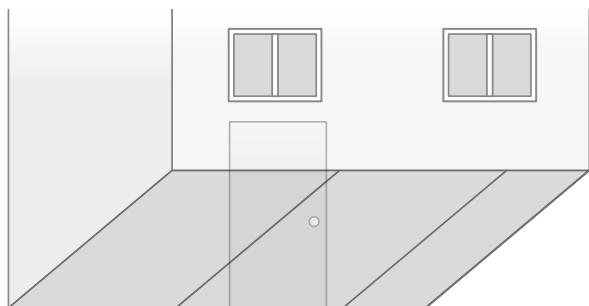

Repeat the same operation with the second half of sheets.

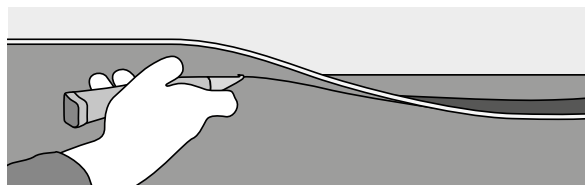

When gluing and pressing is done, excess of material close to walls and obstacles can be trimmed/flushed (freehand cut).

### Tools for freehand trimming:

#### ◉ Knife:

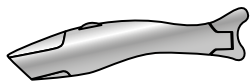

#### ◉ Hook and concave blades:



### 15 ◉ Final pressing

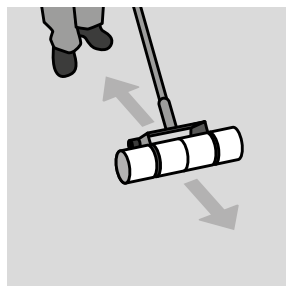
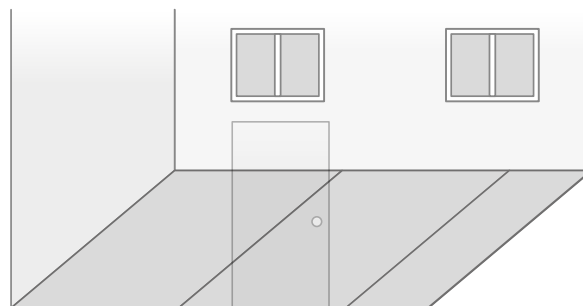

And then, use the heavy roller (mini 50kg) to ensure the final bonding.

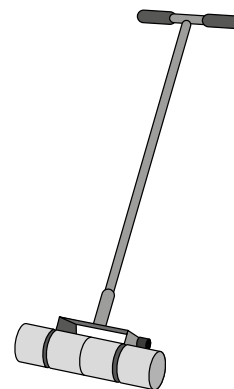

### 16 ◉ Hot or cold welding

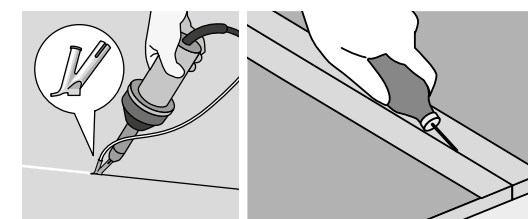
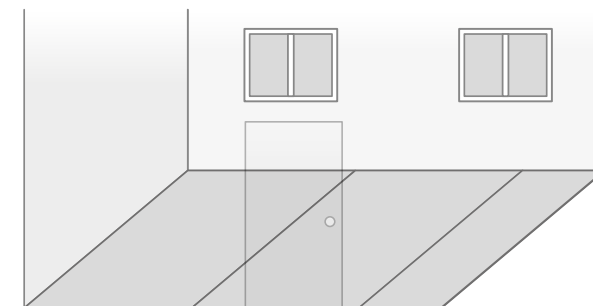

### More détail page 14 & 15

#### Specific case of Linoleum:

- Due to jute backing, linoleum will require wet bonding installation and due to its construction, installer will have to use scribing tools to trim edges and joints. For more details, please refer to the specific Linoleum installation instruction.

# 4. INSTALLATION

Please refer to each individual installation notice per product range, adhesive chart with Tarkett selection as guide line.



## 4.1 GENERAL RULES

### ■ Laying - Tiles

1 ◉ Room dimensions

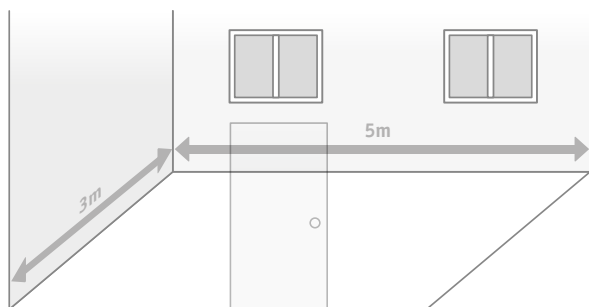

2 ◉ Layout

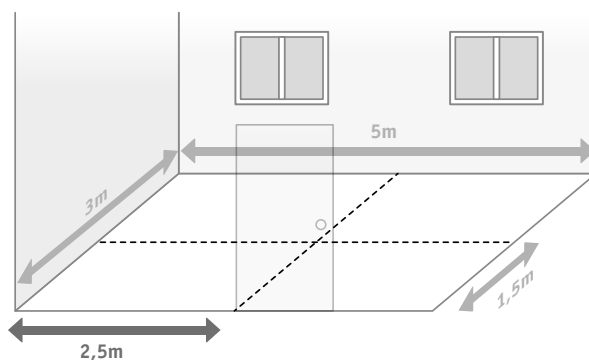

3 ◉ Reference axes

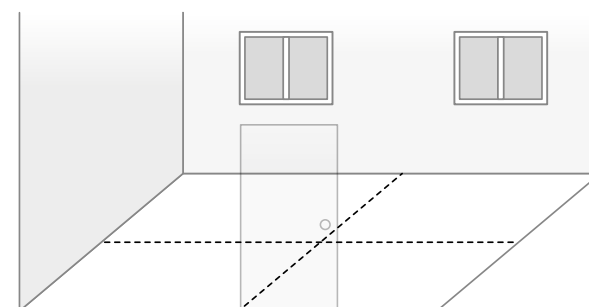

4 ◉ Starting lines definition

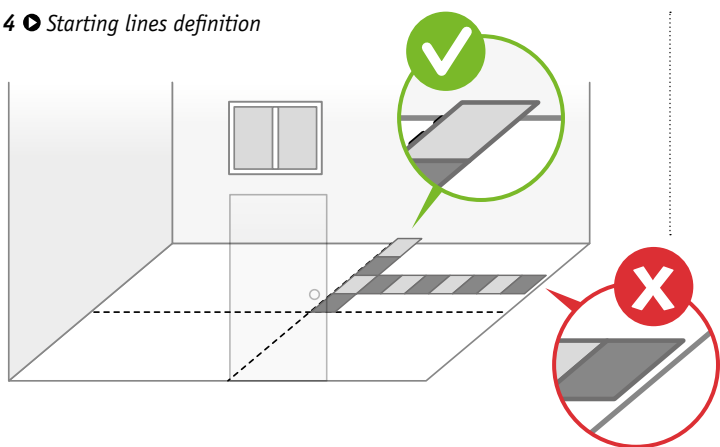

5 ◉ Reference line

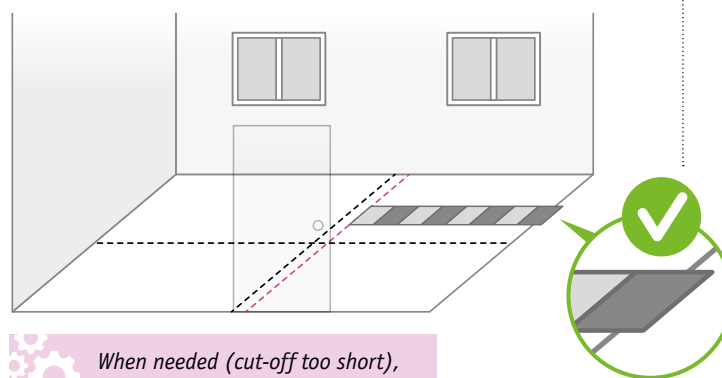

When needed (cut-off too short), shift the reference line.

6 ◉ Gluing

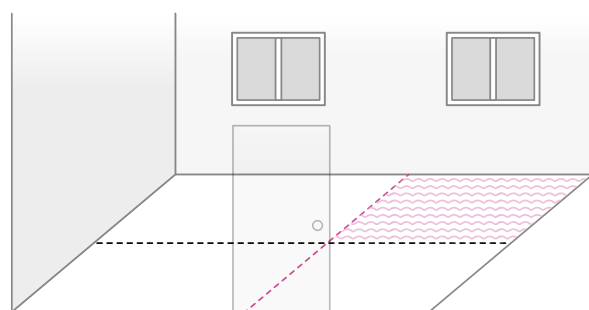

# 4. INSTALLATION

Please refer to each individual installation notice per product range, adhesive chart with Tarkett selection as guide line.



## ■ Laying - Tiles

### 7 Placement

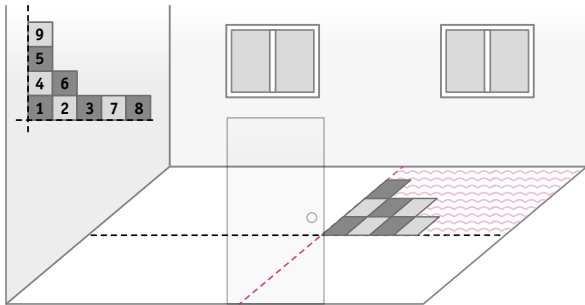

### 8 Scribing

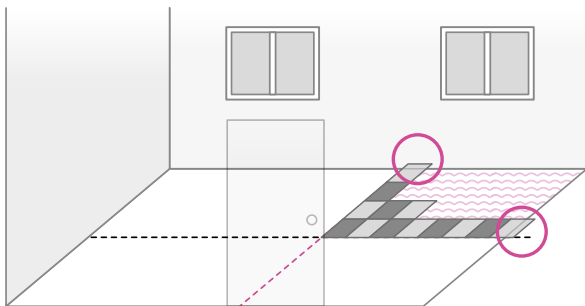

### ► Scribing

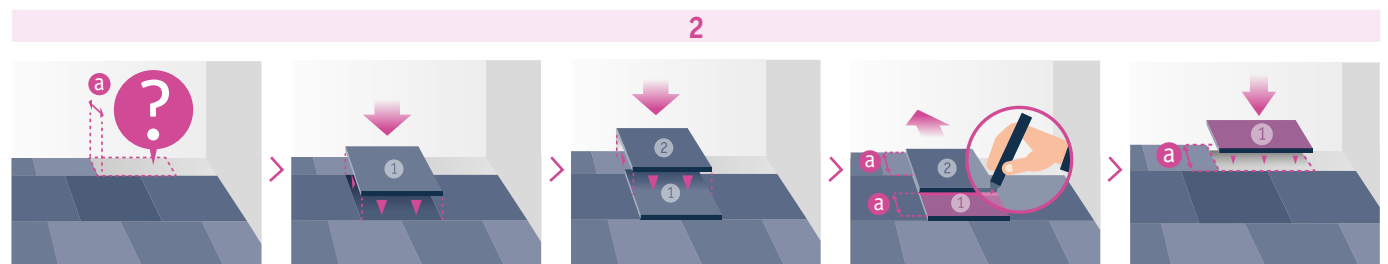
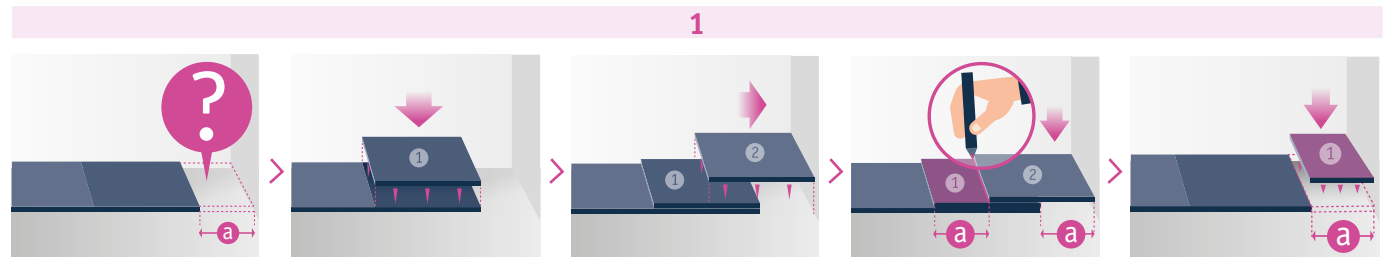
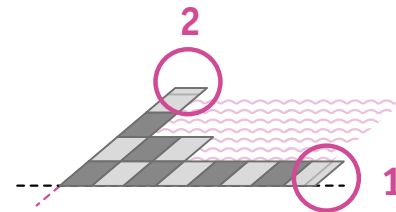

# 4. INSTALLATION

Please refer to each individual installation notice per product range, adhesive chart with Tarkett selection as guide line.



## ■ Laying - Tiles / Diagonal installation

### ▶ Scribing

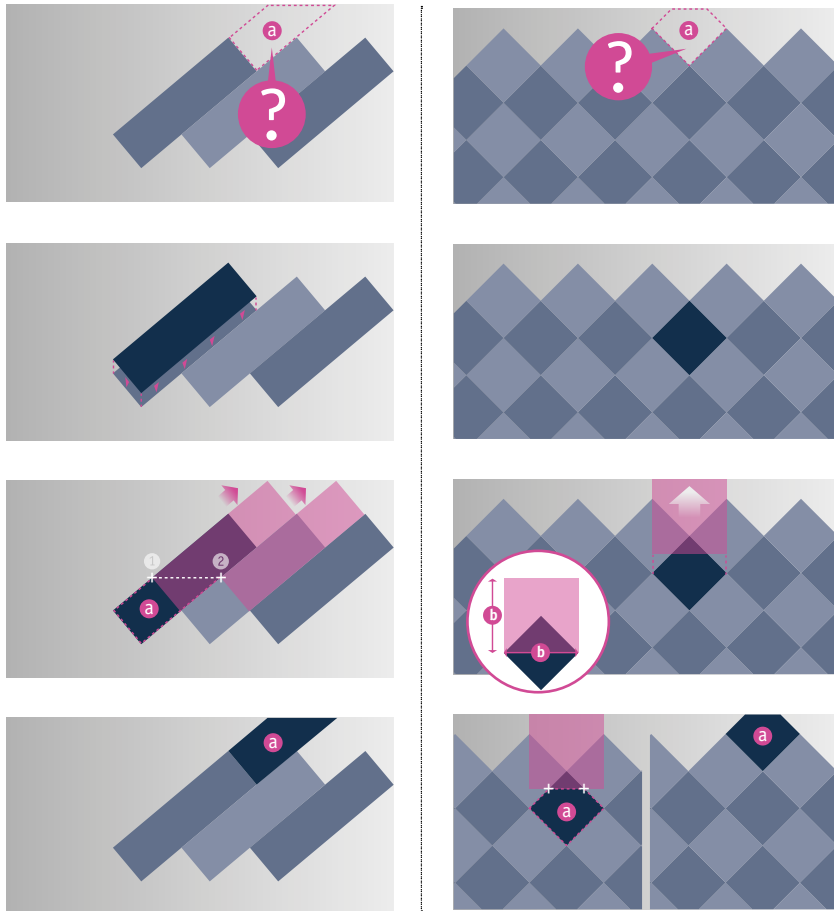

### ▶ Continue with the other quarters

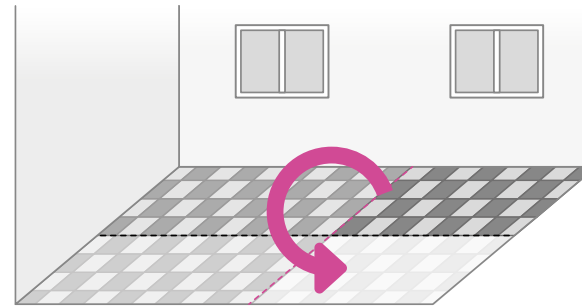

### ▶ Pressing of the whole installation

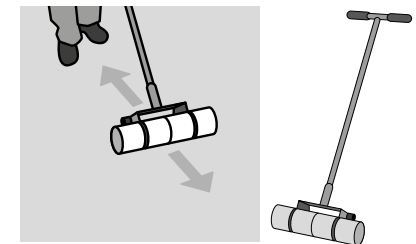
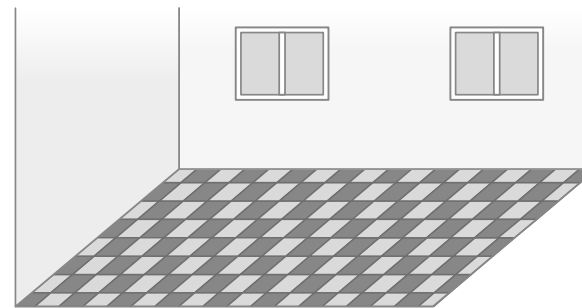

Repeat the same operation with the second half of sheets. And then, use the heavy roller (mini 50kg) to ensure the final bonding.

# 4. INSTALLATION

Please refer to each individual installation notice per product range, adhesive chart with Tarkett selection as guide line.



## ■ Joints welding

According to the product installed and the classification of the room, you could either hot weld (all types of flooring) or cold weld the joints (PVC HE only). Joints treatment depends on room classification; please refer to your country regulation to determine which type is accepted/required.

### Hot welding (min. 24h after installation):

#### ► Grooving

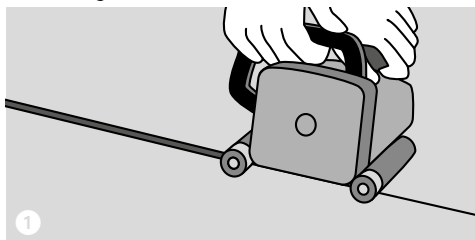

#### ► Welding

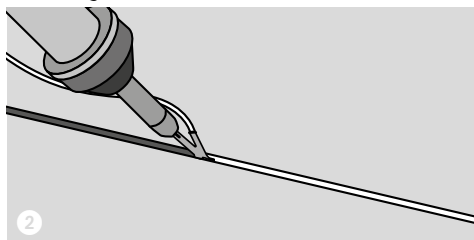

#### ► Trimming (x2)

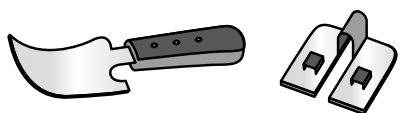
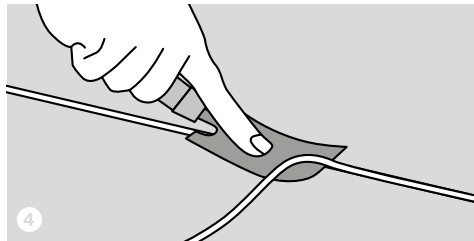
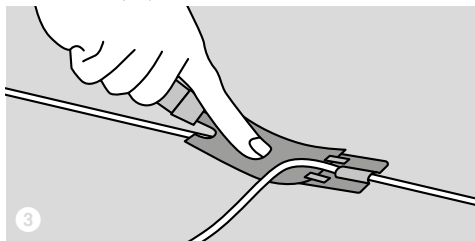

► Quater moon knife

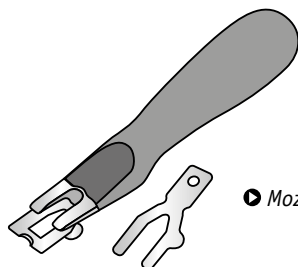

► Mozart

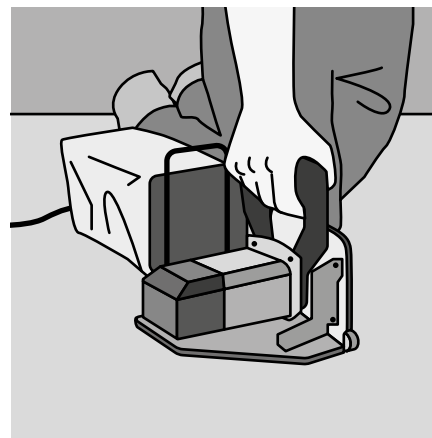

► Grooving machine

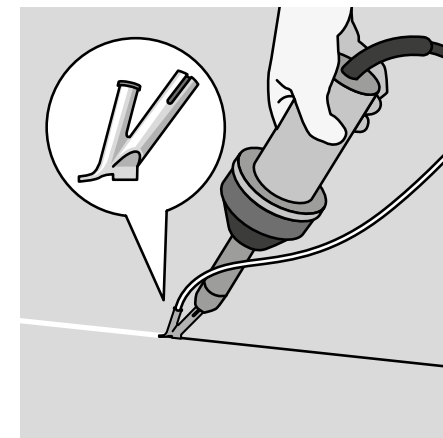

► Hot air welding gun + Nozzle

### Recap table of welding parameters

Flooring	Gap between product	Groove	Deepness	Nozzle	T°c	Speed	Trimming guide
Ho	Crédit Cart 0.8mm		2/3 of the thickness for compact, till foam for acoustic and till jute for linoleum but max. 2.5mm	Hot spped nozzle	350 - 400°C	± 2ml/min	0.5 for compact and 0.7 for acoustic
He	0						
Li	Crédit Cart 0.8mm			Open nozzle	500 - 550°C		Flooring

### Results of welding after trinning

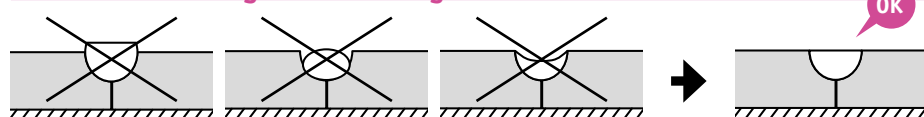

! Always adapt the t°C speed & pression to the situation.



# 4. INSTALLATION

Please refer to each individual installation notice per product range, adhesive chart with Tarkett selection as guide line.



## Cold welding (min. 24h after installation):

### ► Overlap flooring and cut both layers

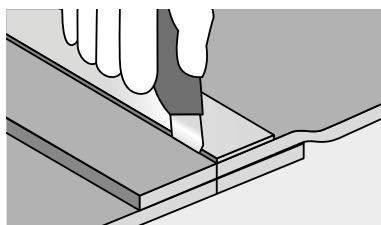

- Realization 24 hours after installation.
- Overlap the 2 sheets till the potential pattern match is achieved.
- The overlapping will be double cut in one step or 2 in case of thick flooring alongside a metal ruler.

**Result should be an extremely tight joint.**

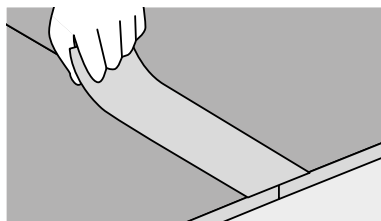

- Fix a special masking tape, centred over the cut seam, then cut the masking tape with the rolling knife within the seam.

- Apply the cold welding liquid by pressing the needle deeply into the seam.

**Important: ensure you apply enough liquid along the entire joint.**

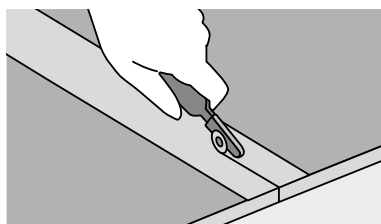

### ► Apply cold welding solution

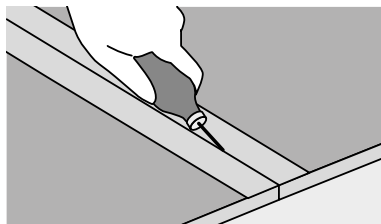

- After 10 minutes the cold-welding liquid on the masking tape should be dry and the tape is removed carefully backwards.

**The seam can be walked on after 24h.**

## 4.2 SPECIFIC PRODUCTS

For the following products: Linoleum, conductive floorcovering, stairs, wet room concept, please refer to specific installation instructions.

## 4.3 COVE FORMING

In particular cases (wet room concept, hospital...), cove forming could be mandatory.

### ► With a cove former

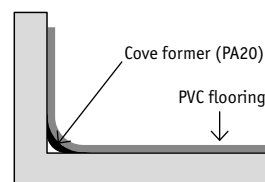

### ► By thermoforming

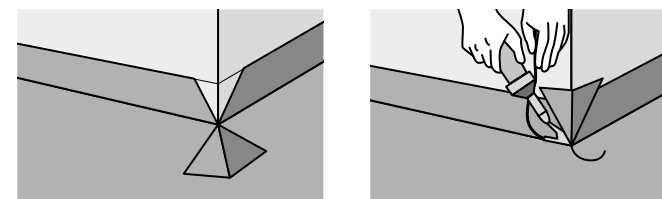
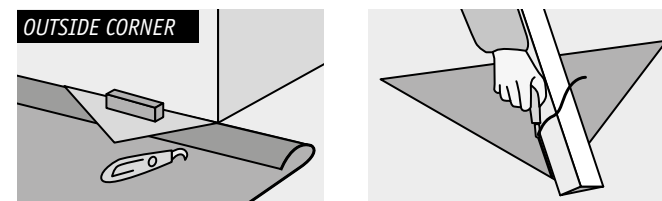
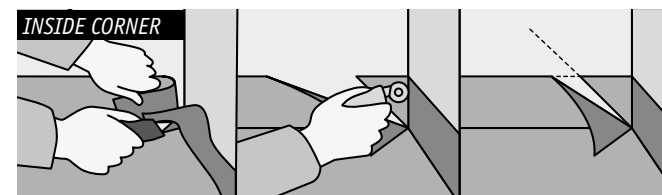
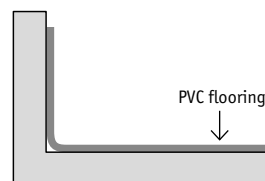

## 4.4 ACCESSORIES

Many accessories are available to complete the installation: stairs profiles and borders, warning strips and signage, wall profiles, skirting...

## 5. INSPECTION (acc. to DTU 53.2 P1-1)

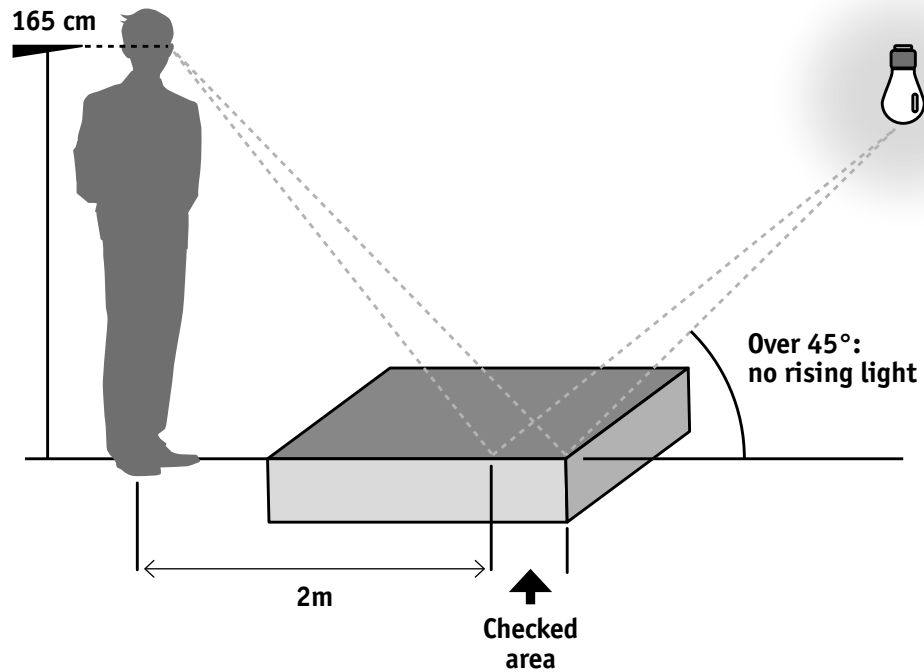

## 6. AFTER INSTALLATION



- Clean working area from all adhesive marks, stains and dust.
- Prevent soiling by protecting the area.
- Open the area to normal traffic 48 hours after installation and move furnitures after 72 hours.

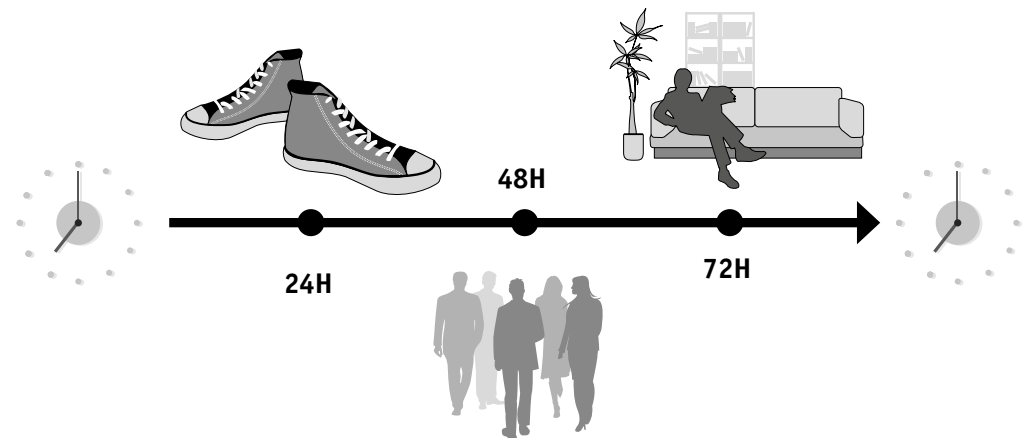

# 7. REMINDER



	Linoleum	PVC He	PVC Ho
<b>Transport &amp; Storage</b>			
<b>Transport &amp; Downloading</b>	<b>Transport:</b> - <b>Truck:</b> laying (3 rolls max) - <b>Container:</b> standing - <b>Unloading:</b> very carefully (role should not fall down)	<b>Transport :</b> - <b>Truck :</b> laying (3 rolls max) - <b>Container :</b> standing - <b>Unloading :</b> carefully	<b>Transport :</b> - <b>Truck :</b> laying (3 rolls max) - <b>Container :</b> standing - <b>Unloading :</b> carefully
<b>Handling</b>	Trolley	Trolley	Trolley
<b>Transport &amp; Downloading</b>	Standing Let labels visible ! Acclimatization 48h	2m: standing, +2m: laying Let labels visible ! Acclimatization 48h	2m: standing, +2m: laying Let labels visible ! Acclimatization 48h
<b>Installation</b>			
<b>Tooling</b>	Specific tools: long scribber, joints scribber, edge trimmer, linoleum hammer, spatula B1 for compact and spatula A2 for Silencio	Spatula A1 compact and A2 acoustic	Mix of linoleum and PVC He, you can use some of the tools from both products spatula A1
<b>Subfloor preparation</b>	Same preparation, see rules in each country		
<b>Subfloor conditions</b>	Same conditions, depends on the country, not the product (maximum humidity level with CCM 4,5% in France, 2% for international...)		
	Min 18°C in the room Min 15°C on the floor	Min 15°C in the room Min 10-12°C on the floor	
<b>Room conditions</b>	35 to 65% of humidity in the room (for acrylic glue)		

# 7. REMINDER



	Linoleum	PVC He	PVC Ho
<b>Installation</b>			
<b>Installation</b>	Long scribber for walls, edge trimmer one side, overlapping one side with joint scribber	Edge to edge tight, when damaged or for overlapping re-cut with steel roller (called also double cut)	Mix of linoleum and PVC He, you can use some of the installation mode from both products
<b>Laying down</b>	Same laying direction (except for Elle design), no coving of edges floor / wall rolls: ≤32lm for compact and ≤30lm for Silencio Carefully, from wall to wall	Opposite laying direction, expect wood (not bambou) rolls: 23 ml Easy, from middle of room	Mix of linoleum and PVC He, you can use some of the laying mode from both products (depends on room)
<b>Cutting</b>	Pre-cut with long and joint scribber + cutting with hooked knife	Free hand along the wall with hooked knife	Mix of linoleum and PVC He, you can use some of the laying mode from both products (depends on room)
<b>Gluing</b>	Compact : wet bonding with lino adhesive, B1 spatula / Silencio: standard bonding with adhesive for PVC , A2 spatula	PVC adhesives, A1 compact and A2 acoustic spatula, finger test to check waiting time	PVC adhesives, A1 compact spatula, finger test to check waiting time
<b>Welding</b>	Lino welding rod (thermo-gluing), 500°c minimum, 2 to 2,5mm grooving deepness and lino speed nozzle, double cut (trim) of the rod, first one after 5 minutes and second one when the rod is cold	PVC welding rod, 400°c, hot speed nozzle, 1,5mm grooving deepness, double cut (immediate and after 5 minutes) of welding rod	
<b>Initial cleaning</b>	Depending on protection of the floor and on dirtiness, clean with neutral detergent and water, stains with adapted chemical product, follow maintenance instructions given by Tarkett.		